

pHTemp2000

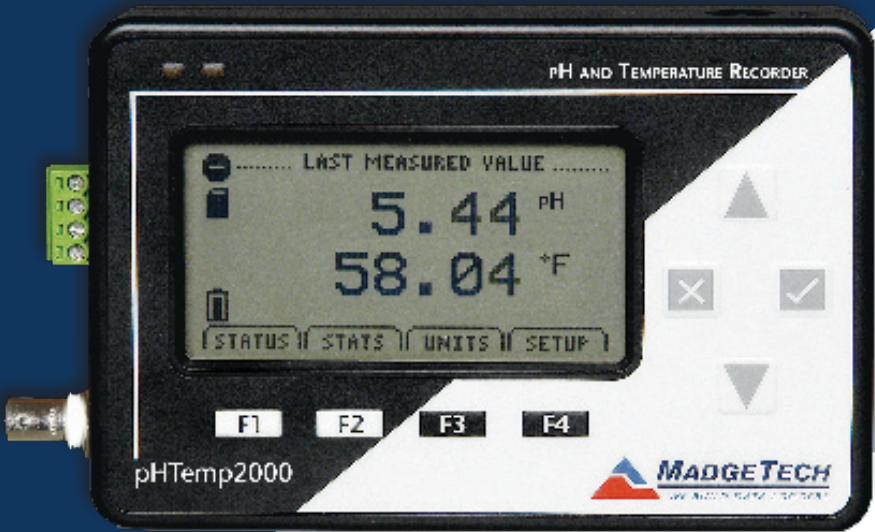

Data Logger Manual

Table of Contents

Section 1: Device Safety	3
1.1 Model information	3
1.2 Specifications	3
1.3 Warranty	5
Section 2: Device Overview	6
Section 3: Status Indicator Icons	7
3.1 Battery Status	7
3.2 Memory Status	7
3.3 Running Indicator.....	7
3.4 Delay Start Indicator	8
3.5 Wait Icon.....	8
3.6 Stop Icon.....	8
3.7 External Power Icon	8
3.8 Reset Icon.....	8
Section 4: Front Panel Overview	9
4.1 Changing the display units	9
4.2 Changing the number, type, and size of channels viewed.....	9
4.3 Checking the memory status	10
4.4 Checking power status	10
4.5 Changing the Contrast.....	10
Section 5: pHTemp2000 Function Reference	11
5.1 Main Screen	11
5.2 Status Menu	11
5.3 Statistics Menu	12
5.4 Units.....	13
5.5 Setup Menu	13
Section 6: pHTemp2000 Screen Descriptions	18
6.1 Main Screen:	18
6.2 Status Screens (Run Parameters):	18
6.3 Status Screens (Memory Status):.....	19
6.4 Status Screens (Time):	19
6.5 ID Parameters	20
6.6 Statistics Menu Screen:.....	20

MadgeTech pHTemp2000

6.7 Temperature Channel Statistics:.....	21
6.8 pH Channel Statistics:.....	21
6.9 Type Statistics:.....	22
6.10 Statistics Information Screen:.....	22
6.11 Unit Selection Menu:.....	23
6.12 Device Configuration Menu:.....	23
6.13 Adjust Visibility:	24
6.14 Display Configuration:.....	24
6.15 Power Modes Screen:	25
6.16 Display Update Mode Screen:.....	26
6.17 Power Status Screen:	26
6.18 Device Information Screens (Minimum Device Range):.....	27
6.19 Device Information Screens (Maximum Device Range):	27
6.20 Device Information Screens (Device Version):	28
6.21 Device Information Screens (Firmware Version):	28
6.22 Calibration Information Screens (Calibration Date):	29
6.23 Calibration Information Screens (Internal Temperature Cal.):	29
6.24 Calibration Information Screens (External Probe Calibration):	30
6.25 Device Reset Screen (Hardware Reset):	30
6.26 Device Reset Screen (Power Interruption):	31
Section 7: Computer Interface	32
Section 8: Wall Mounting	33
Section 9: Maintenance	34
Section 10: Terms and Conditions.....	35
10.1 Limited Warranty:.....	35
10.2 Limitations:.....	36
10.3 Software License:.....	36

Section 1: Device Safety



CAUTION: DEVICE MUST BE USED ONLY IN A MANNER CONSISTENT WITH THIS MANUAL.

NOTICE: WHEN 230VAC SUPPLY USED, MADGETECH SPECIFIES USE OF AC SUPPLY PART # T35-9-100R-3 MANUFACTURED BY ENG ELECTRIC. THIS SUPPLY IS AVAILABLE FROM MADGETECH.

1.1 Model information

- Model: pHTemp2000
- Description: Measure & record pH and temperature using an external probe with LCD display
- Manufactured by MadgeTech, Inc. Warner, NH USA

1.2 Specifications

Temperature*

Measurement Range: -40 to 110C (80 to 144 ohms)

Resolution: 0.01C (0.001 ohms)

Calibrated Accuracy: $\pm 0.1^{\circ}\text{C}$ @ 25°C Ambient (± 0.015 ohms)

Input Connection: RTD; Removable screw terminal; 2, 3, or 4-wire RTD Probe**

pH

pH Range: 0~14pH ($\pm 1000\text{mV}$)

pH Resolution: 0.01pH

Dot-Matrix LCD

Dimensions: 2.5" x 1.375" (63mm x 35mm)

Text: Configurable channel text size

Indicators: Power, status, memory

Backlight: Configurable w/auto shut-off and contrast adjustment

*Temperature specifications based on an ideal 100 ohm Pt RTD compliant with IEC 751 (1983) and ITS-90, 5000 ohms FSR

**A compatible RTD probe is required to accurately measure pH

MadgeTech pHTemp2000

Start/Stop Time:

Software programmable start time and date, up to six months in advance; programmable stop method, manual, timed, or by readings.

Memory:

131,071 readings per channel; 262,143 total readings; software configurable memory wrap

Reading Rate:

1 reading every 2 seconds to 1 every 24 hours

Calibration:

Digital calibration through software

Calibration Date:

Automatically recorded within device

Battery Type:

9V lithium battery included, user replaceable; optional AC adapter, 7-24 VDC Volts, 100mA. For 230 VAC operation use AC supply T35-9-100 R-3 made by ENG Electric.

Battery Life:

30 days typical @ 1 min reading rate with continuous LCD and no backlight usage. 1 year battery life at 1 minute reading rate with display off

Data Format:

Date and time stamped °C, °F, °K, °R, mV potential, pH

Time Accuracy:

±1 minute/month (at 20° to 30°C)

Computer Interface:

PC serial or USB (interface cable required); 115,200 baud

Software:

Windows 95/98/ME/NT/2000/XP/Vista based software

Operating Environment:

-20 to +60°C, 0 to 95%RH non-condensing

Dimensions:

4.8" x 3.3" x 1.25" (122mm x 84mm x 32mm)

Weight:

16 oz (440 g)

Enclosure:

Black anodized aluminum

1.3 Warranty

Products manufactured by MadgeTech, Inc., are warranted against defective material and workmanship for a period of one year, starting from the date of shipment. In the event that a MadgeTech product is found to be defective, MadgeTech will repair or replace the product at its sole discretion. Such repair or replacement shall be the sole remedy of this warranty.

This warranty extends only to the original purchasing customer and does not apply to any unit, which in our sole judgment, has been subjected to:

- a) Operating or environmental conditions in excess of our written specifications or recommendations;
- b) Damage, misuse or neglect;
- c) Improper installation, repair or alteration.

This warranty excludes batteries.

Except as to title, this is our only warranty for the products. MadgeTech, Inc. expressly disclaims all other warranties, guarantees or remedies—whether expressed or implied or statutory—including any implied warranty of merchantability or fitness for a particular purpose. We also disclaim any implied warranty arising out of trade usage or out of a course dealing or course of performance. We do not guarantee the integrity of data or warranty that the products will operate uninterrupted or error-free.

MadgeTech data loggers and their associated software have been thoroughly tested and the documentation reviewed. However, MadgeTech does not warrant the performance of its products, or that the products or their associated software will operate as described in this manual.

Please refer to page 35 for MadgeTech's complete Terms and Conditions.

Section 2: Device Overview

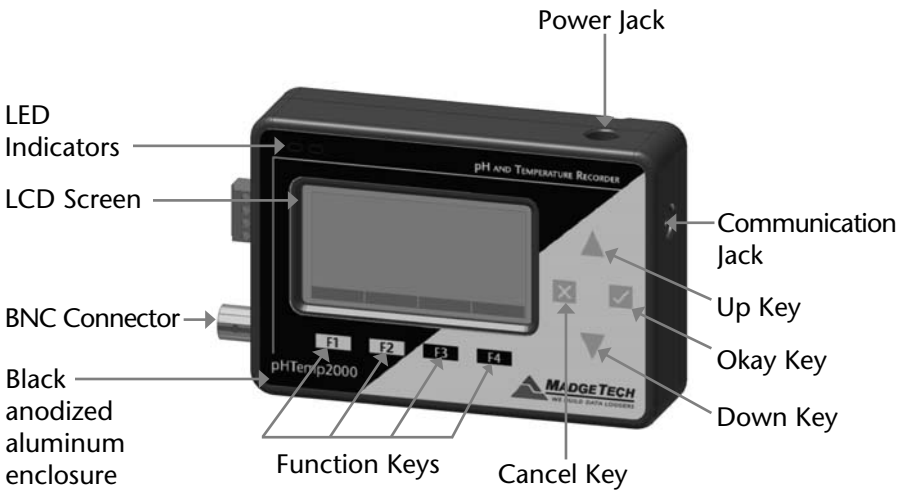

Section 3: Status Indicator Icons

3.1 Battery Status



Full
Battery

Empty
Battery

Battery status icons indicate the state of charge of the batteries. When the battery empty indicator is displayed, the battery should be replaced.

3.2 Memory Status



Memory
Empty

Memory
Full

The memory status icons indicate the amount of memory left for data storage. If the pHTemp2000 is in wraparound mode, the memory status icon will always indicate empty.

3.3 Running Indicator

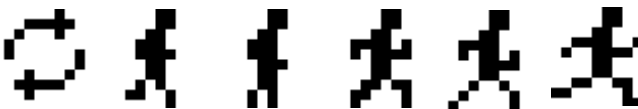

Indicates that the pHTemp2000 is taking readings. The icons cycle periodically.

MadgeTech pHTemp2000

3.4 Delay Start Indicator



The delay start icon indicates that a logging operation is scheduled for the future.

3.5 Wait Icon



The wait icon indicates that the device is busy.

3.6 Stop Icon



Indicates that the pHTemp2000 is not currently taking readings.

3.7 External Power Icon



Indicates that the pHTemp2000 is powered by an external source.

3.8 Reset Icon



Indicates that the device has been reset.

Section 4: Front Panel Overview

4.1 Changing the display units

The pHTemp2000 comes with factory default display units of °C for the RTD temperature channel, and pH for the pH channel. These units can be easily changed by pressing the F3 button in the main screen and then selecting either F1 for the RTD temperature or F2 for pH probe. After selecting a channel, the available units can be scrolled through by either pressing the channel's function key repeatedly or using the UP and DOWN keys.

Button pressing chain:

Main Screen -> F3 -> F1(temp), F2(pH) -> function key repeatedly or UP and DOWN

4.2 Changing the number, type, and size of channels viewed

By default the pHTemp2000 displays recently measured values of both channels (RTD temperature and pH probe) on its Main Screen with the two channels taking up the maximum amount of screen space available. Channels can, however, be hidden or viewed on a smaller or larger scale.

To change the number and type of displayed channels:

From the Main Screen, press the F4 key to enter the Setup Menu and from this menu press the F1 key to enter the Display screen. On this screen, F1 corresponds to the RTD temperature channel and F2 to the pH probe. Pressing these function keys will cause the channels to scroll between "show" or "hide" channels displaying "show" will appear on the main screen and channels displaying "hide" will not. Any number of channels between zero and two may be shown.

Button pressing chain:

Main Screen -> F4 -> F1 -> F1(internal temp) or F2 (pH probe)

To change the size of displayed channels:

From the Main Screen, press the F4 key to enter the Setup Menu and from this menu press the F1 key to enter the Display screen, then F4 to scroll to the next screen. Here the F2 key will change the size of the channels viewed. By pressing F2 repeatedly the size parameter will scroll between 3 sizes:

Small: Both channels can be displayed and appear much smaller than the available screen space.

Medium: Both channels can be displayed and take up two-thirds of available screen space.

MadgeTech pHTemp2000

Large: Both channels can be displayed and take up entire available screen space.

Button pressing chain:

Main Screen -> F4 -> F1 -> F4 -> F2 repeatedly to scroll or UP and DOWN to scroll

4.3 Checking the memory Status

A status icon appears on all screens representing memory, but further information including percent memory left and number of readings taken can also be viewed. From the Main Screen press the F1 key to enter the Status screens then press F2 to view memory status information.

Button pressing chain:

Main Screen -> F1 -> F2

4.4 Checking power status

A battery status and external power status (if available) icon appear on all screens, but percent battery power remaining and external power presence as well as battery type, current battery voltage, and current external voltage can also be viewed. From the Main Screen press F4 to view the Device Configuration Menu, F2 to access the power options, then F4 twice to view the Power Status screen, including battery power percent remaining and the presence of external power. Battery type and battery voltage are also displayed, as well as external power voltage (if connected).

Button pressing chain:

Main Screen -> F4 -> F2 -> F4 -> F4

4.5 Changing the Contrast

The pHTemp2000's LCD screen contrast values can be changed in two ways. One method is outlined in the Function Reference Guide. A faster, simpler way involves simultaneously pressing the CANCEL and UP or DOWN repeatedly in any screen.

Button pressing chain:

CANCEL("X") + UP repeatedly (to increase) or DOWN repeatedly (to decrease)

Section 5: pHTemp2000 Function Reference

5.1 Main Screen

The main screen of the pHTemp2000 features a real-time display of most recently measured RTD temperature and pH probe data. At the bottom of the main screen are tabs corresponding to each of the four function keys. These tabs are used to access the four main function menus of the pHTemp2000: status, statistics, units, and setup. The left side of the main screen and all subsequent screens of the device is where important status information icons can be found (detailed in Section 3: Status Indicator Icons – page 7) including recording status, memory status, busy status, external power status, and battery power status.

5.2 Status Menu

Pressing F1 on the main screen brings up the Status menu. The first screen that appears in the Status Menu is Run Parameters, but the Memory Status and Time screens can also be viewed by pressing the F2 and F3 keys respectively.

5.2.i Run Parameters

The Run Parameters screen displays important information regarding the device's current recording session. These parameters include the time and date the recording session started (start time and start date), the time and date the recording session will end (stop date and stop time) due to either lack of memory or preprogramming in the MadgeTech software. The rate at which the pHTemp2000 is recording (rate) is also displayed. The device's current status (either running or stopped) is the last parameter on the Run Parameters screen.

5.2.ii Memory Status

The Memory Status screen is where all information regarding the pHTemp2000's memory is displayed. This screen displays the percent of memory space currently available (memory left), the number of readings currently stored on the device (readings), the maximum number of readings the device can record (max readings), as well as information about the wrap feature displaying either "disabled" or the number of wrap readings currently stored in memory.

5.2.iii Time

The time screen displays current time data including the current time and date, time and date of last measured data, and current time zone.

5.3 Statistics Menu

Pressing the F2 key while in the Main Screen brings up the Statistics Menu. From the Statistics Menu, statistics generated from the conditions encountered by the device can be viewed in a variety of different styles including being sorted by channel and by type. The Statistics Menu also displays important statistics information as well as the option to clear the statistics at any time.

5.3.i Viewing statistics by channel

Pressing F1 while viewing the Statistics Menu brings up statistics sorted by channel. Here the F1 and F2 keys provide the ability to view statistics regarding the internal ambient temperature and the external probe channels respectively. Each channel screen displays the minimum, maximum, and average values encountered by the device for a particular channel.

5.3.ii Viewing statistics by type

The pHTemp2000's Statistics Menu also provides the option to view statistics by type. This can be done by pressing F2 while in the Statistics Menu. Here the function keys F1, F2, and F3 correspond to the three different types of statistics: average, minimum, and maximum respectively. Each type screen displays the values of RTD temperature and the pH probe data encountered by the device.

5.3.iii Statistics Information

Pressing the F3 key while viewing the Statistics Menu screen brings up Statistics Information. This screen displays the number of readings being considered within the statistics (readings), as well as the date and time the recording period began. From this screen the statistics information can also be cleared. This is done by pressing the F1 key marked by a tab labeled "CLEAR". Upon pressing this key a confirmation message will appear with function tabs labeled "NO" and "YES" corresponding to F1 and F2 respectively. Selecting "YES" by pressing the F2 key will confirm the statistics clear function.

5.4 Units

Pressing the F3 key while viewing the Main Screen will access the Units Selection screen. Here the measurement units can be easily changed. In the Units Selection screen the F1 and F2 function keys correspond to the two channels RTD temperature and pH probe respectively. Selecting a channel by pressing its corresponding function key allows the user to change the units by either pressing the function key repeatedly or using the UP and DOWN keys to scroll through the list of available units. Selecting OK (either by pressing the OK button or the F4 key) accepts and confirms the unit selection. Pressing the CANCEL key cancels the unit changing action and reverts to the previously selected units. The pHTemp2000 offers most commonly used units.

5.5 Setup Menu

Pressing the F4 key while in the Main Screen will display the Device Configuration screen. From this menu, changes can be made to most of the pHTemp2000's display configuration including the screen contrast, size of the channel view in the main screen, as well as display of the channels. Power status can also be viewed including battery power remaining and the presence of external power, and options regarding the LCD display and the backlight can be modified. The setup menu is also the place to find basic information regarding device identification, calibration parameters, and firmware details.

5.5.i Display

From the Display section, the number and identity of channels shown on the main screen can be changed and set, the LCD screen's contrast values can be changed and set, and the size the channel information appears on the main screen can be changed and set. Pressing F1 while in the Setup Menu brings up the Display section.

5.5.i.a Adjust Visibility

The first screen that appears in the Display section is the Adjust Visibility screen. Here the F1 and F2 keys correspond to the RTD temperature and pH channels respectively. Pressing one of these function keys results in highlighting its corresponding channel function tab. While a channel is highlighted the corresponding display function can be toggled between "Hide" and "Show", with "Hide" indicating that the channel will not be displayed on the main screen and "Show" indicating that it will be shown. Channels can be toggled by either repeatedly pressing

MadgeTech pHTemp2000

the channel's corresponding function key or by using the UP and DOWN keys.

5.5.i.b Display Configuration

By selecting "MORE" (either by pressing the F4 key on the Adjust Visibility Screen or by pressing the OK button) in the Display section the Display Configuration screen can be viewed. Here LCD screen contrast values can be set as well as the size the channels are displayed on the Main Screen.

Contrast

To change the LCD screen contrast view while viewing the Display Configuration screen, first select the contrast configuration parameter by pressing the F1 key. This action will highlight the function tab corresponding to the F1 key. Once this tab is highlighted the contrast can be increased or decreased using the UP and DOWN keys.

Size

To change the size that each channel is displayed on the Main Screen view while viewing the Display Configuration screen, first select the size configuration parameter by pressing the F2 key. This action will highlight the function tab corresponding to the F2 key. Once this tab is highlighted the size can be increased or decreased using the UP and DOWN keys. Sizes are as follows:

Small: Both channels can be displayed and appear much smaller than the available screen space.

Medium: Both channels can be displayed and take up two-thirds of available screen space.

Large: Both channels can be displayed and take up entire available screen space.

5.5.ii Power

The Power section displays information regarding battery and external power sources as well as giving options including display and backlight status that could potentially save power and LED status options.

5.5.ii.a Power Modes

The power modes screen displays information regarding the display, backlight, and LED mode as well as the options to change their function.

Display

The pHTemp2000's LCD screen has options to be either on continuously or turn off automatically after 5 minutes of inactivity. This option can be changed by first pressing the F1 key to highlight the display parameter configuration tab. Once the tab is highlighted the option can be changed by pressing the F1 key repeatedly or using the UP and DOWN keys to select either "On" or "Auto".

Backlight

Like the display, the LCD screen's backlight also has power saving options. The backlight can be either on continuously, off, or set to automatically shut off after 30 seconds of inactivity. This option can be changed by first pressing the F2 key to highlight the backlight parameter configuration tab. Once the tab is highlighted the option can be changed by pressing the F2 key repeatedly or using the UP and DOWN keys to select either "On", "Off" or "Auto".

LED Modes

The function of the two LEDs on the upper left corner of the pHTemp2000 can be regulated by first pressing the F3 key to highlight the LED parameter configuration tab. Once the tab is highlighted the option can be changed by pressing the F3 key repeatedly or using the UP and DOWN keys to select either "Enabled" meaning the LEDs will light to indicate device function or "Disabled" meaning the LEDs will never light.

5.5.ii.b Display Update Mode

Selecting "MORE" by either pressing the F4 key or "OK" key while viewing the Power Modes screen brings up the Display Update Mode screen. On this screen, options relating to the refresh rate of the screen are displayed. The F1 key toggles between 'auto' and 'reading' modes. In 'auto' mode, the display is updated periodically, whereas in 'reading' mode, the display only updates after a reading is taken. F2 selects the update period option. Pressing the "UP" and "DOWN" keys increase and decrease the update period respectively.

MadgeTech pHTemp2000

5.5.ii.c Power Status

Selecting “MORE” by either pressing the F4 key or the OK key while viewing the Display Update Mode screen brings up the Power Status screen. On this screen the battery type is displayed and should be changed by the user based on whether a Lithium or Alkaline battery is used in the pHTemp2000. This can be changed by first pressing the F1 button to highlight the type parameter configuration tab. Once the tab is highlighted, the battery type can be changed by either pressing the F1 key repeatedly or by using the UP and DOWN arrows to select the correct battery type. The percent battery power remaining, external power presence, battery voltage and external power voltage are also displayed on the Power Status screen.

5.5.iii Device Information

The F3 key in the Setup Menu displays the Device Information screens. Here device identification information can be found including serial number, product ID, revision, and subtype. Calibration parameters are also found under device information including the date the device was last calibrated and when it will be due for calibration again. Firmware details are also found here.

5.5.iii.a Device Range (Minimum)

The Minimum Device Range screen can be accessed by pressing the F1 key while viewing the Device Information screen. This display indicates the minimum values which the pHTemp2000 is capable of detecting and logging, for the RTD or pH type. Values on this screen cannot be modified.

5.5.iii.b Device Range (Maximum)

The Maximum Device Range screen can be accessed by pressing the F2 key while viewing the Minimum Device Range screen. This display indicates the maximum values which the pHTemp2000 is capable of detecting and logging, for the RTD or pH type. Values on this screen cannot be modified.

5.5.iii.c Calibration Parameters

Pressing F3 while in the Maximum or Minimum Device Range screens will display the device calibration parameters. This screen displays information indicating the most recent calibration date as well as the date the next calibration will be due.



It is important to keep your device properly calibrated to ensure accurate readings.

5.5.iii.d Device Version

Pressing the F4 key while viewing the Maximum or Minimum Device Range screens will display the Device Version screen, containing information such as firmware revision number and communications baud rate. Values on this screen cannot be modified.

5.5.iii.e Firmware Version

Firmware details can be viewed by pressing the F2 key while viewing the Device Version screens. These details include the firmware version number, date and time of firmware creation, and checksum.

Section 6: pHTemp2000 Screen Descriptions

6.1 Main Screen:

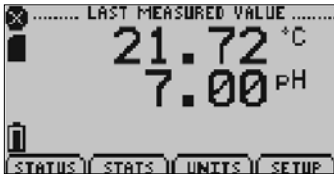

Displays last measured values.

F1 = STATUS: goes to status screens

F2 = STATS: shows statistics menu

F3 = UNITS: goes to unit selection screen

F4 = SETUP: shows device configuration menu

CANCEL = no function

OK = no function

UP = scrolls channel readings (only available while using large text)

DOWN = scrolls channel readings (only available while using large text)

6.2 Status Screens (Run Parameters):



Displays information about run parameters including date of recording start (start date), time of recording start (start time), stop date, stop time, recording rate, and current status.

For all status screens:

F1 = RUN: displays run parameters screen

F2 = MEM: displays memory status screen

F3 = TIME: displays date and time screen

F4 = MORE: displays the second status screen

CANCEL = returns to main screen

MadgeTech pHTemp2000

- F3** = TIME: displays date and time screen
- F4** = MORE: displays ID parameters screen
- CANCEL** = returns to main screen
- OK** = returns to main screen
- UP** = no function
- DOWN** = no function

6.5 ID Parameters



Displays information relating to device identity.

- F1** = ID: no function
- F3** = MORE: displays the first status screen
- F4** = EXIT: returns to main screen
- CANCEL** = returns to main screen
- OK** = returns to main screen
- UP** = no function
- DOWN** = no function

6.6 Statistics Menu Screen:

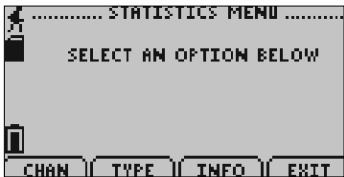

Displays options available within the statistics menu.

- F1** = CHAN: goes to screen that sorts statistics by channel
- F2** = TYPE: goes to screen that sorts statistics by type
- F3** = INFO: goes to Statistics Information Screen
- F4** = EXIT: returns to main screen
- CANCEL** = returns to main screen

OK = returns to main screen

UP = no function

DOWN = no function

6.7 Temperature Channel Statistics:

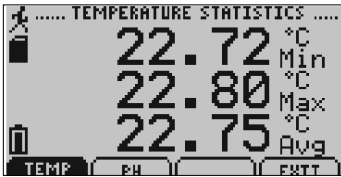

Displays temperature statistics (maximum recorded value, minimum recorded value, and average recorded value, must use small or medium sized font to view all on one screen) based on channel (RTD Temperature or pH Probe).

F1 = TEMP...: Displays RTD temperature statistics

F2 = pH: Displays pH probe statistics

F3 = no function

F4 = EXIT: returns to Statistics Menu Screen

CANCEL = returns to Statistics Menu

OK = returns to Statistics Menu

UP = no function

DOWN = no function

6.8 pH Channel Statistics:



Displays pH statistics (maximum recorded value, minimum recorded value, and average recorded value, must use small or medium sized font to view all on one screen) based on channel (RTD Temperature or pH Probe).

F1 = TEMP...: Displays RTD temperature statistics

F2 = pH: Displays pH probe statistics

MadgeTech pHTemp2000

F3 = no function

F4 = EXIT: returns to Statistics Menu Screen

CANCEL = returns to Statistics Menu

OK = returns to Statistics Menu

UP = no function

DOWN = no function

6.9 Type Statistics:

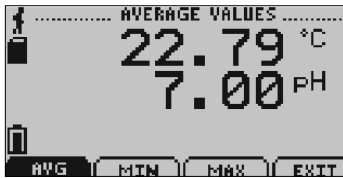

Displays statistics from pH statistics (maximum recorded value, minimum recorded value, or average value).

F1 = AVG: displays average recorded value for each channel

F2 = MIN: displays minimum recorded value for each channel

F3 = MAX: displays maximum recorded value for each channel

F4 = EXIT: Returns to Statistics Menu

CANCEL = returns to Statistics Menu

OK = returns to Statistics Menu

UP = no function

DOWN = no function

6.10 Statistics Information Screen:



Displays current statistics information including the number of recorded readings, start date, and start time.

F1 = CLEAR: Gives the option to clear all statistics

F2 = no function

F3 = no function

F4 = EXIT: returns to Statistics Menu

CANCEL = returns to Statistics Menu

OK = returns to Statistics Menu

UP = no function

DOWN = no function

6.11 Unit Selection Menu:



Displays units currently being used for each channel

F1 = TEMP: selects RTD temperature channel for unit change

F2 = PROBE: selects pH probe channel for unit change

F3 = no function

F4 = OK: returns to Main Screen

Note: unit selection can be changed by pressing the corresponding function key repeatedly or using the UP and DOWN arrows to select appropriate units.

CANCEL = returns to main menu without accepting changes

OK = accepts changes and returns to main menu

6.12 Device Configuration Menu:

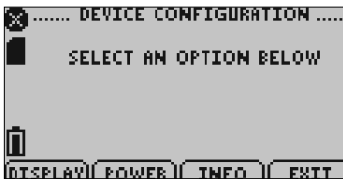

Displays options available within the device configuration menu.

F1 = DISPLAY: enters Adjust Visibility screen

F2 = POWER: enters Power Modes screen

F3 = INFO: goes to Device Information screens

F4 = EXIT: returns to main screen

MadgeTech pHTemp2000

CANCEL = returns to main screen

OK = returns to main screen

UP = no function

DOWN = no function

6.13 Adjust Visibility:



Displays options for changing the viewing of both channels on the main screen (either shows a particular channel or hides it.)

F1 = TEMP: first highlights and then changes the viewing options of the RTD temperature channel

F2 = PROBE: first highlights and then changes the viewing options of the pH probe channel

F3 = no function

F4 = MORE: moves on to Display Configuration screen

CANCEL = return to Display Configuration Menu

OK = moves on to Display Configuration screen

UP = once channel parameter configuration tab is highlighted scrolls through available options

DOWN = once channel parameter configuration tab is highlighted scrolls through available options

6.14 Display Configuration:



Allows the user to change the contrast of the LCD display as well as the channel size.

- F1 = CNTRST:** highlights the contrast parameter configuration tab
- F2 = SIZE:** highlights and then changes options of the channel size parameter
- F3 = MORE:** moves back to the Adjust Visibility screen
- F4 = EXIT:** returns to Display Configuration Menu
- CANCEL =** returns to Device Configuration Menu
- OK =** moves back to the Adjust Visibility screen
- UP =** when contrast parameter configuration tab is highlighted increases contrast value
- DOWN =** when contrast parameter configuration tab is highlighted decreases contrast value

6.15 Power Modes Screen:

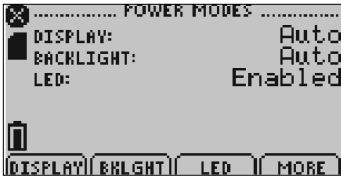

Displays information regarding the devices different power modes including the display visibility, backlight options, and LED modes.

- F1 = DISPLAY:** first highlights and then changes display visibility (On: full visibility or Auto: shuts off after 5 minutes of inactivity)
- F2 = BKLIGHT:** first highlights and then changes backlight options (On: backlight always on, Auto: backlight shuts off after 30 sec of inactivity, or Off: backlight always off)
- F3 = LED:** first highlights and then changes LED mode options
- F4 = MORE:** moves to Display Update Mode screen
- CANCEL =** Returns to Device Configuration Menu
- OK =** moves to Display Update Mode screen
- UP =** once parameter configuration tab is highlighted scrolls through available options
- DOWN =** once parameter configuration tab is highlighted scrolls through available options

6.16 Display Update Mode Screen:

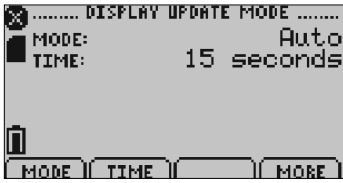

Displays information regarding display refresh mode and refresh interval.

F1 = MODE: first highlights and then changes update mode (Auto: screen refreshes periodically or Reading: refreshes only after a reading is taken)

F2 = TIME: first highlights and then changes refresh interval.

F4 = MORE: moves to Power Status screen

CANCEL = Returns to Device Configuration Menu

OK = moves to Power Status screen

UP = once parameter configuration tab is highlighted scrolls through available options

DOWN = once parameter configuration tab is highlighted scrolls through available options

6.17 Power Status Screen:

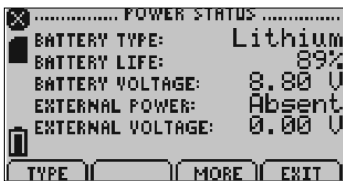

Displays details about power available to the device including the battery type, battery voltage, and external voltage.

F1 = TYPE: highlights and then changes battery type (Lithium or Alkaline)

F3 = MORE: moves back to Power Modes screen

F4 = EXIT: Returns to Device Configuration Screen

CANCEL = Returns to Device Configuration Menu

OK = moves back to Power Modes screen

UP = if type parameter configuration tab is highlighted, scrolls through available options

DOWN = if type parameter configuration tab is highlighted, scrolls through available options

6.18 Device Information Screens (Minimum Device Range):

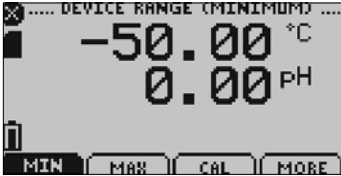

Displays values indicating minimum internal temperature and external probe data (for thermocouple selected) detectable by the pHTemp2000.

For all Device Information Screens:

F1 = MIN: no function

F2 = MAX: shows Device Range (Maximum) screen

F3 = CAL: shows Calibration Information screens

F4 = MORE: shows further Device Information screens

CANCEL = Returns to Device Configuration Menu

OK = Returns to Device Configuration Menu

UP = No function

DOWN = No function

6.19 Device Information Screens (Maximum Device Range):



Displays values indicating maximum RTD temperature and pH probe data detectable by the pHTemp2000.

6.20 Device Information Screens (Device Version):



Displays device version information.

F1 = VERS: no function

F2 = FIRM: shows Firmware Version screen

F3 = MORE: shows Device Range (Minimum) screen

F4 = EXIT: Returns to Device Configuration Menu

CANCEL = Returns to Device Configuration Menu

OK = Returns to Device Configuration Menu

UP = No function

DOWN = No function

6.21 Device Information Screens (Firmware Version):



Displays device firmware version information.

F1 = VERS: shows Device Version screen

F2 = FIRM: no function

F3 = MORE: shows Device Range (Minimum) screen

F4 = EXIT: Returns to Device Configuration Menu

CANCEL = Returns to Device Configuration Menu

OK = Returns to Device Configuration Menu

UP = No function

DOWN = No function

6.22 Calibration Information Screens (Calibration Date):



Displays date of last calibration and due date of next calibration.

For all Device Information Screens:

F1 = DATE: no function

F2 = TEMP: shows RTD temperature calibration information

F3 = pH: shows pH probe calibration information

F4 = EXIT: returns to Device Configuration Menu

CANCEL = Returns to Device Configuration Menu

OK = Returns to Device Configuration Menu

UP = No function

DOWN = No function

6.23 Calibration Information Screens (Internal Temperature Calibration):



Displays calibration information for internal temperature channel.

F1 = DATE: shows calibration date information

F2 = TEMP: Shows RTD calibration information

F3 = pH: shows pH probe calibration information

F4 = MORE: shows further calibration information screens

CANCEL = Returns to Device Configuration Menu

OK = Returns to Device Configuration Menu

UP = No function

DOWN = No function

6.24 Calibration Information Screens (External Probe Calibration):



Displays calibration information for external probe channel.

F1 = DATE: shows calibration date information

F2 = TEMP: shows RTD temperature calibration information

F3 = pH: shows pH calibration information

F4 = Exit

CANCEL = Returns to Device Configuration Menu

OK = Returns to Device Configuration Menu

UP = No function

DOWN = No function

6.25 Device Reset Screen (Hardware Reset):



Displayed as notification when a hardware reset has occurred.

F1 = OK: accepts notification and displays main screen

F2 = no function

F3 = no function

F4 = no function

CANCEL = no function

OK = accepts notification and displays main screen

UP = no function

DOWN = no function

6.26 Device Reset Screen (Power Interruption):



Displayed as notification when power is interrupted during device operation.

F1 = OK: accepts notification and displays main screen

F2 = no function

F3 = no function

F4 = no function

CANCEL = no function

OK = accepts notification and displays main screen

UP = no function

DOWN = no function

Section 7: Computer Interface:

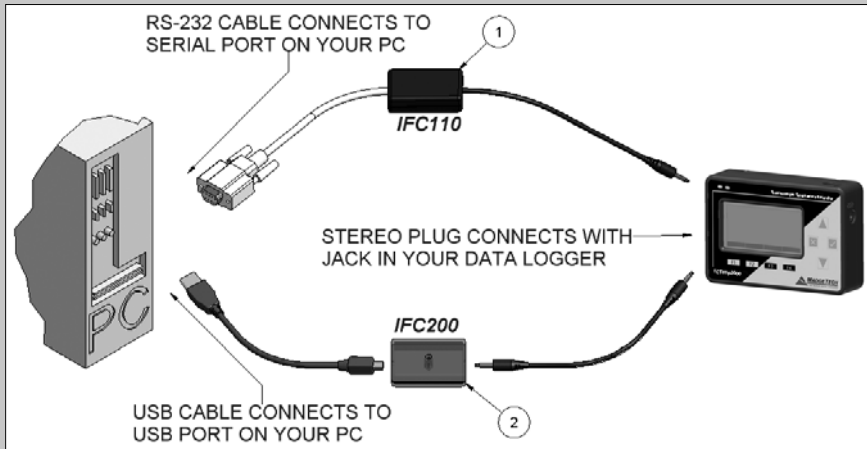

1. Fully insert the male connector of the IFC110 interface cable into the female receptacle of the data logger. Insert fully the RS232 connector into the Serial Port.

OR

2. Insert the USB connector of the IFC200 into an available USB port. Fully insert male connector of the IFC200 interface cable into the female receptacle of the data logger*.

**WARNING: Install driver before connecting a device using a USB for the first time. See the MadgeTech Data Logger Software manual for further information.)*

Note: Most MadgeTech data loggers can use both IFC110 and IFC200 interface cables. For interface cable data logger clarification contact technical support at 603-456-2011 or support@madgetech.com.

Section 8: Wall Mounting

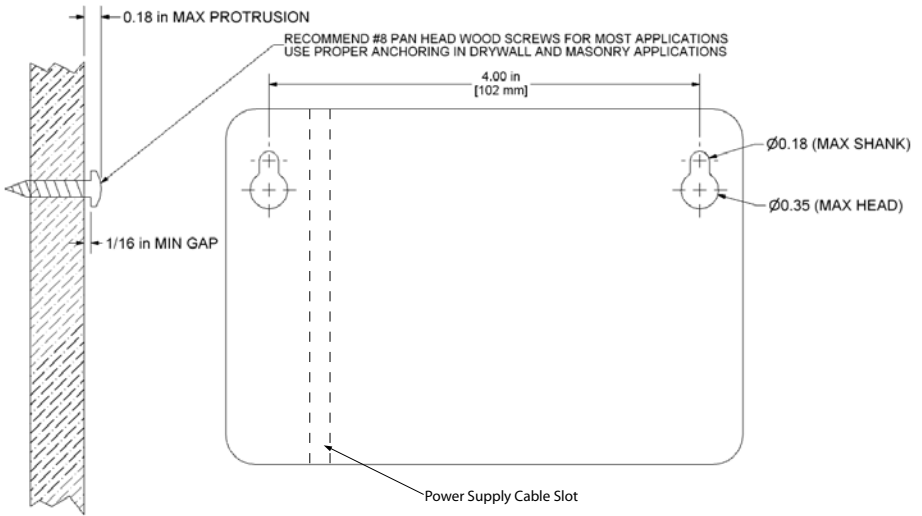

Section 9: Maintenance

BATTERY WARNING

Most MadgeTech data loggers contain a lithium battery. Do not cut the battery open, incinerate, or recharge. Do not heat lithium batteries above the specified operating temperature.* Dispose of the battery in accordance with local regulations.

*See the individual specification sheets at www.madgetech.com.

The pHTemp2000 does not have any user-serviceable parts except the battery which should be replaced periodically. The battery life is affected by battery type, ambient temperature, sample rate, sensor selection, offloads and LCD display usage. The pHTemp2000 has a battery status indicator on the LCD display. If the battery indication is low, or if the device seems to be inoperable, it is recommended that the battery be changed.

To change the battery, locate and remove the four (4) 3/32 hex screws on the back of the unit. Separate the halves and the battery compartment is now visible. Remove the old 9V battery from the battery clips and replace with a new 9V battery. MadgeTech recommends using 9V lithium battery. An alkaline battery is acceptable, but will yield a shorter battery life.

Reminders:

- A 2,3, or 4 wire RTD probe is required to accurately measure pH.
- A resistor may be used to simulate a temperature if an RTD is not available. (MadgeTech does not stock resistors)

For any other maintenance or calibration issues, MadgeTech recommends the unit be returned to the factory for service. Before returning the device, you must obtain an RMA from the factory. For further information, please contact MadgeTech at:

MadgeTech, Inc.

PO Box 50

Warner, NH 03278

TEL: 603-456-2011 • FAX: 603-456-2012

support@madgetech.com

www.MadgeTech.com

Section 10: Terms and Conditions

All products furnished by MadgeTech, Inc. ("Seller") shall be in accordance with the following terms and conditions unless otherwise stated in writing:

These Terms and Conditions ("Terms and Conditions") govern (a) all sales quotations and sales of components, equipment, parts, and other products ("Product") from, and (b) all service proposals and provisions of services by Seller to the buyer of the Products ("Buyer"). These Terms and Conditions shall take precedence over any terms and conditions which appear on Buyer's order or other form or any other writing or electronic transmission from Buyer. Any terms or conditions on any of Buyer's forms, recordings, electronic transmissions, or orders that are different from or in addition to these Terms and Conditions are specifically rejected. Any modification to these Terms and Conditions must be agreed to and executed in writing by Seller. Seller's failure to object to provisions contained in any communication from Buyer shall not be construed as a waiver of these Terms and Conditions or as an acceptance of any such provision. Trade custom, trade usage and past performance are superseded by these terms and conditions and shall not be used to interpret these terms and conditions. In the event that Product includes software, the software is licensed to Buyer in object code form only in accordance with Seller's standard Software License Terms that are included below.

10.1 Limited Warranty.

A. Seller Manufactured Products and Seller Provided Services.

Seller warrants to Buyer that:

- (i) Seller manufactured Software (as defined in Section 23 below) shall execute the programming instructions provided by Seller, and
- (ii) Seller manufactured Product and consumables and Seller provided services shall be free from material defects in material and workmanship under normal uses and care, in each case until the expiration of the applicable warranty period specified below

Seller manufactured Product is warranted for the shorter of twelve (12) months from the date of initial installation or fifteen (15) months from the date of shipment by Seller. Seller manufactured consumables and Software, and Seller provided services are warranted for a period of ninety (90) days from the date of shipment or completion, as applicable. If Buyer discovers any warranty defect and notifies Seller thereof in writing during the applicable warranty period, Seller shall, at its option, promptly correct any defects that are found by Seller, or repair or replace F.O.B. point of manufacture that portion of the Seller manufactured Products, consumables or Software found by Seller to be defective, or refund the price of the defective portion of the Seller manufactured Products, consumables or Software, or of the defective portion of the Seller provided services. All replacements or repairs necessitated by inadequate maintenance, normal wear and usage, unsuitable power sources, unsuitable environmental conditions, accident, misuse, improper installation, modification, repair, storage or handling, or any other cause not the fault of Seller are not covered by this limited warranty, and shall be at Buyer's expense. Seller shall not be obligated to pay any costs or charges incurred by Buyer or any other party except as may be agreed upon in writing in advance by an authorized representative of Seller. All costs of dismantling, re-installation and freight, and the time and expenses of Seller's personnel for site travel and diagnosis under this limited warranty shall be borne by Buyer unless accepted in writing by Seller. Seller manufactured Products, consumables and Software, and Seller provided services, repaired, replaced or corrected during the applicable warranty period shall be in warranty for the greater of the remainder of the applicable original warranty period or ninety (90) days.

THE FOREGOING STATES THE SOLE AND EXCLUSIVE WARRANTY AND LIABILITY OF SELLER. FOR BREACH OF WARRANTY AND IS IN LIEU OF ALL OTHER REPRESENTATIONS, WARRANTIES AND COVENANTS, EXPRESSED OR IMPLIED, IN REGARD THERETO. EXCEPT FOR THE EXPRESS LIMITED WARRANTY SET FORTH IN THIS SECTION, SELLER DOES NOT MAKE AND HEREBY DISCLAIMS ANY AND ALL OTHER REPRESENTATIONS AND WARRANTIES OF ANY KIND WHATSOEVER, WHETHER EXPRESSED, IMPLIED OR STATUTORY, INCLUDING, WITHOUT LIMITATION, ANY

MadgeTech pHTemp2000

IMPLIED WARRANTIES OF MERCHANTABILITY, FITNESS FOR A PARTICULAR PURPOSE, NON-INFRINGEMENT OR ACCURACY, ADEQUACY OR COMPLETENESS OF DATA MEASUREMENT, WITH RESPECT TO ANY OF THE SELLER MANUFACTURED PRODUCTS, CONSUMABLES OR SOFTWARE, OR ANY OF THE SELLER PROVIDED SERVICES.

Any drawings submitted with the Products are only to show the general style, arrangement, and approximate dimensions of the Products.

B. Equipment, Consumables, Software and Services Manufactured or Provided by Others.

SELLER DOES NOT MAKE, AND HEREBY DISCLAIMS, ANY AND ALL REPRESENTATIONS AND WARRANTIES OF ANY KIND WHATSOEVER, WHETHER EXPRESSED, IMPLIED OR STATUTORY, INCLUDING, WITHOUT LIMITATION, ANY IMPLIED WARRANTIES OF MERCHANTABILITY PARTICULAR PURPOSE, NON-INFRINGEMENT OR ACCURACY, ADEQUACY OR COMPLETENESS OF DATA MEASUREMENT, WITH RESPECT TO ANY EQUIPMENT, COMPONENTS, PARTS, CONSUMABLES, SOFTWARE OR SERVICES SOLD TO BUYER BY SELLER THAT ARE NOT MANUFACTURED OR PROVIDED BY SELLER. Seller shall assign the manufacturer's or service provider's warranty applicable to such equipment, components, parts, consumables, Software and services to the extent permitted, to Buyer. Seller will provide Buyer with available warranty information.

10.2 Limitations.

IN NO EVENT, REGARDLESS OF THE FORM OF THE CLAIM OR CAUSE OF ACTION (WHETHER BASED IN CONTRACT, INFRINGEMENT, NEGLIGENCE, STRICT LIABILITY, OTHER TORT OR OTHERWISE), SHALL SELLER'S LIABILITY EXCEED THE PRICE ACTUALLY PAID BY BUYER TO SELLER FOR THE SPECIFIC PRODUCTS, CONSUMABLES AND/OR SOFTWARE MANUFACTURED, AND/OR SERVICES PROVIDED, BY SELLER GIVING RISE TO THE CLAIM OR CAUSE OF ACTION. SELLER SHALL NOT, UNDER ANY CIRCUMSTANCES, BE LIABLE FOR ANY LOSS OF REVENUE, LOSS OF PROFITS OR ANY INCIDENTAL, INDIRECT, SPECIAL, EXEMPLARY OR CONSEQUENTIAL DAMAGES, WHETHER OR NOT FORESEEABLE. NO ACTION, REGARDLESS OF FORM, ARISING OUT OF ANY TRANSACTION GOVERNED BY THESE TERMS AND CONDITIONS, MAY BE BROUGHT BY EITHER PARTY MORE THAN TWO (2) YEARS AFTER THE CAUSE OF ACTION HAS ACCRUED. The foregoing allocation of risk and limitation of liability has been agreed to by the parties and forms the basis of their willingness to enter into any accepted order.

10.3 Software License.

(A) For purposes hereof, "Software" means the computer programs included in the Product at delivery, together with all codes, techniques, software tools, formats, designs, concepts, methods, and ideas associated with those computer programs. The term also includes all copies of any part of the software, as well as the manual(s) and printed materials provided by Seller.

(B) Seller grants Buyer a non-exclusive, non-transferable license to use the Software, in object code form only, according to the terms set forth below. Buyer may operate the Software only (i) in conjunction with and as part of the Product; (ii) in the manner in which it is intended by Seller; and (iii) at Buyer's plant site where the Product is first used. Buyer may negotiate with Seller separate licenses to use the Software at other plant sites. Buyer's use of Software shall be governed exclusively by Seller's and/or an third party owner's applicable license terms.

(C) Buyer shall not (i) make the Software available to any person or entity other than its employees, who must use the Software only as specified above; (ii) modify the Software or merge it with another program; (iii) reverse engineer, disassemble, decompile, or make any attempt to discover the source code of the Software; (iv) translate or create derivative works based on the Software; (v) remove, obscure, or alter any notice of the patent, copyright, or other proprietary rights related to the Software; (vi) sub-license, sell, lend, rent, or lease any portion of the Software; (vii) copy any portion of the Software; (viii) operate the Software other than in conjunction with operation of Product; or (ix) transfer the Software in violation of applicable United States Export laws and regulations.

PO Box 50, Warner, NH 03278
Phone 603.456.2011 • Fax 603.456.2012
www.madgetech.com • info@madgetech.com