

INSTRUCTION MANUAL

MW190 MAX

Dissolved Oxygen & Temperature Bench Meter





THANK YOU for choosing Milwaukee Instruments!

This instruction manual will provide you the necessary information for correct use of the meter.

All rights are reserved. Reproduction in whole or in part is prohibited without the written consent of the copyright owner, Milwaukee Instruments Inc., Rocky Mount, NC 27804 USA.

TABLE OF CONTENTS

1. PRELIMINARY EXAMINATION	4
2. INSTRUMENT OVERVIEW	5
3. SPECIFICATIONS.....	6
4. FUNCTIONAL & DISPLAY DESCRIPTION.....	8
5. MA845 PROBE DESCRIPTION.....	11
6. GENERAL OPERATIONS.....	12
6.1. POWER CONNECTION & BATTERY MANAGEMENT.....	12
6.2. PROBE PREPARATION.....	12
6.3. PROBE MAINTENANCE.....	14
7. SETUP	15
7.1. SETUP OPTIONS.....	15
8. ALTITUDE & SALINITY COMPENSATION	21
9. CALIBRATION.....	22
10. MEASUREMENT.....	25
11. LOGGING.....	27
11.1. TYPES OF LOGGING	27
11.2. DATA MANAGEMENT	29
12. GLP	36
12.1. DO INFORMATION	36
13. TROUBLESHOOTING.....	37
14. ACCESSORIES.....	37
CERTIFICATION.....	38
RECOMMENDATION	38
WARRANTY.....	38

1. PRELIMINARY EXAMINATION

Each bench meter is delivered in a cardboard box and is supplied with:

- **MA845** Dissolved Oxygen and Temperature polarographic probe
- **MA841** Membrane cap and o-ring (2 pcs.)
- **MA9071** Electrolyte solution
- **MA9315** Electrode holder
- Probe protective cap
- 12 VDC adapter
- USB cable
- Instrument quality certificate
- Instruction manual

2. INSTRUMENT OVERVIEW

MW190 is a compact and versatile bench meter designed for testing dissolved oxygen in the pharmaceutical and food industry, as well as monitoring in water treatment plants.

Concentration measurements are automatically compensated for temperature and salinity. Salinity and altitude can be configured in Setup.

Temperature is automatically measured (in both degree Celsius and Fahrenheit) and compensated.

Other features include:

- Easy to read LCD display
- Built-in rechargeable battery with an 8-hour capacity
- Auto-off feature to prolong battery life
- Battery charger with battery monitor
- Internal clock and date to keep track of different time-dependent functions (calibration timestamp, calibration time out)
- Measurement logging (on demand, on stability, interval)
- Available log space for up to 1000 records
- Logged data can be exported using a USB cable or directly on a USB flash drive
- Dedicated GLP key to store and recall data on system status

For accurate measurements, use the electrode holder supplied with the bench meter.

3. SPECIFICATIONS

Range	DO *	0.00 to 45.00 mg/L (ppm) 0.0 to 300.0 %
	Temperature **	-20.0 to 120.0 °C (-4.0 to 248.0 °F)
Resolution	DO	0.01 mg/L (ppm) 0.1 %
	Temperature	0.1 °C (0.1 °F)
Accuracy	DO	±1.5 % of reading ±1 digit
	Temperature	±0.4 °C (±0.8 °F)
Calibration	One- or two-points 0% (MI9070) and 100% (water saturated air)	
Temperature compensation	Automatic, from 0.0 to 50.0 °C (32.0 to 122.0 °F)	
Salinity compensation	0 to 40 g/L (with 1 g/L resolution)	
Altitude compensation	-500 to 4,000 m (-1640' to 13123') with 100 m (328') resolution	
Log	Max. 1000 log records (stored in up to 100 lots) On demand, 200 On stability, 200 Interval logging, 1000	
PC connectivity	1 USB type A port, 1 micro USB port	
Power supply	12 VDC adapter (included)	
Battery life	8 hours	
Environment	0 to 50 °C (32 to 122 °F); maximum RH 95%	
Dimensions	230 x 160 x 95 mm (9.0 x 6.3 x 3.7")	
Weight	0.9 kg (2.0 lb.)	

* DO measurement is performed within the automatic temperature compensation interval.

** Limits will be reduced to actual sensor limits.

PROBE SPECIFICATIONS

DO probe MA845	DO sensor	Polarographic
	Temperature range	0.0 to 50.0 °C (32.0 to 122.0 °F)
	Temperature sensor	Built-in thermistor
	Cathode	Platinum
	Anode	Silver
	Membrane	Oxygen permeable Teflon® membrane
	Connector socket	DIN, 7 pins
	Body	PP, ABS, IP67 rating
	Dimensions	Total length: 160 mm (6.3") Ø 32 mm (1.26")
	Cable	Jacket material: PP

4. FUNCTIONAL & DISPLAY DESCRIPTION

Front Panel

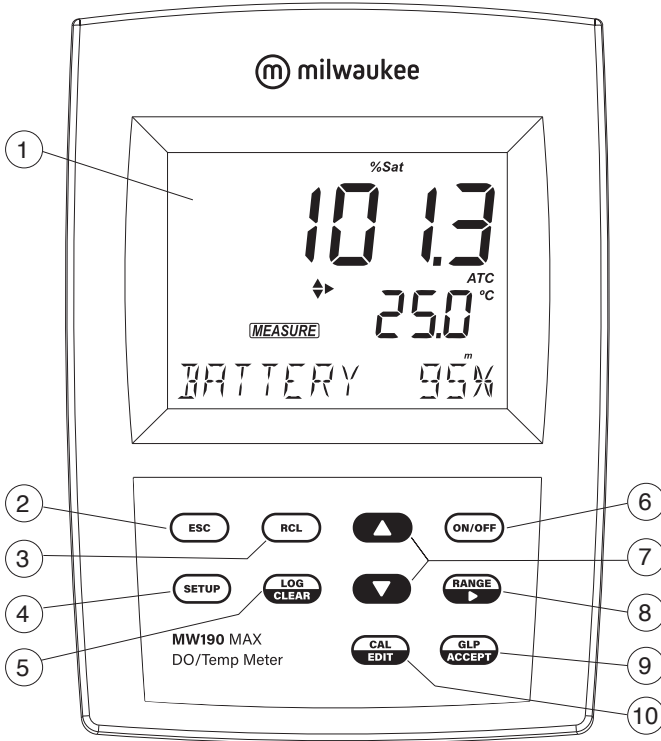

1. Liquid Crystal Display (LCD)
2. ESC key, to exit current mode
3. RCL key, to recall the logged values
4. SETUP key, to enter setup mode
5. LOG/CLEAR key, to log the reading or to clear calibration or logging
6. ON/OFF key
7. ▲▼ directional keys for menu navigation and setting parameters
8. RANGE/► key, to select setup parameters and toggle between measurement units
9. GLP/ACCEPT key, to enter GLP or to confirm selected action
10. CAL/EDIT key, to enter/edit calibration settings, edit setup settings

Rear Panel

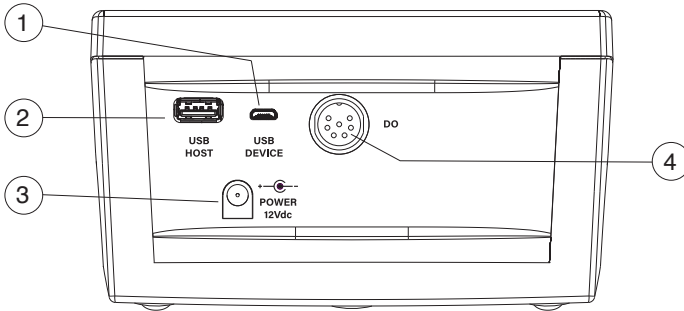

1. Micro USB port
2. USB type A port
3. Power supply socket
4. DIN probe connector

Display Description

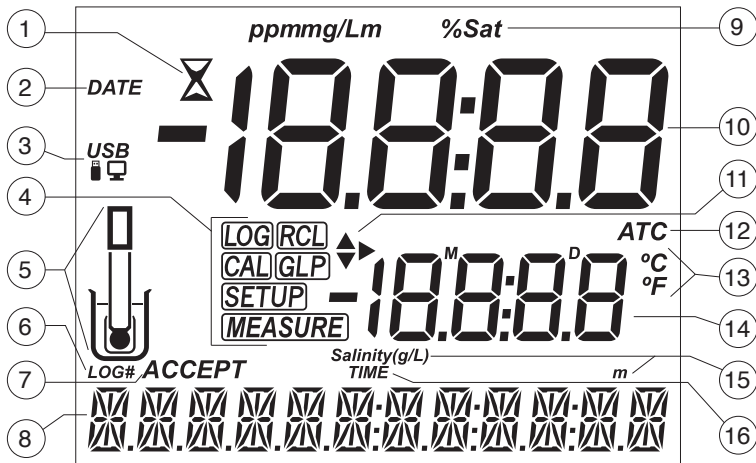

1. Stability indicator
2. Status information
3. USB connection status
4. Mode tags
5. Probe symbol
6. Log tag
7. Accept tag
8. Third LCD line, message area
9. Measurement units
10. First LCD line, measurement readings
11. Arrow tags, to navigate the menu in either direction
12. Automatic temperature compensation tag
13. Temperature units
14. Second LCD line, temperature readings
15. Measurement units for salinity and altitude
16. TIME tag

5. MA845 PROBE DESCRIPTION

The **MA845** probe uses a polarographic dissolved oxygen sensor with a built-in thermistor that allows stable, temperature compensated readings.

The sensor makes use of a platinum cathode, a silver wire anode and electrolyte solution protected by an oxygen permeable membrane. Oxygen that passes through the membrane causes a current flow, from which the oxygen concentration is determined.

The membrane is fixed to a detachable cap that allows for simple replacement and priming.

The probe has a reinforced plastic body for durability.

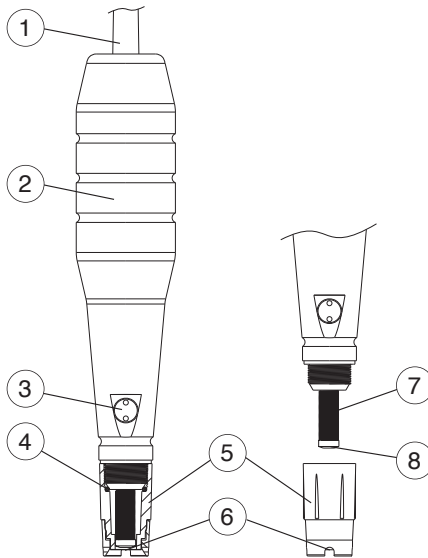

1. Cable jacket
2. Probe body
3. Temperature sensor
4. O-ring seal
5. Membrane cap
6. Oxygen permeable Teflon® membrane
7. Silver wire anode element
8. Platinum cathode (sensor)

6. GENERAL OPERATIONS

6.1. POWER CONNECTION & BATTERY MANAGEMENT

MW190 has a built-in rechargeable battery that provides up to 8 hours of use. The internal battery recharges with the supplied 12 VDC adapter or while connected to a PC USB port or standard 5V USB charger.

MW190 is equipped with Battery Error Prevention System (BEPS) feature, which turns the meter off after 10 minutes of non-use (see Auto Off in SETUP OPTIONS section).

At power on, the instrument performs an auto-diagnostic test and all LCD segments are displayed for a few seconds. Use ▲ ▼ keys to check the battery percentage.

6.2. PROBE PREPARATION

DO probes shipped from Milwaukee Instruments are dry.

Before measurements membrane cap needs to be primed and the probe polarized.

Changing the membrane cap

1. For new probes, remove the red and black shipping cap.
2. Open the supplied membrane package and remove one o-ring and one membrane cap.
3. Soak the bottom 2½ cm (1") of the sensor in **MA9071** electrolyte solution for 5 minutes.
4. Inspect the membrane cap. The membrane is thin and can not be repaired if damaged.
5. Position the o-ring. Prime the cap with electrolyte solution. Shake gently, discard and refill with clean solution making sure to cover the o-ring.
6. Gently tap the side of the cap to remove trapped air bubbles. Do not tap on the membrane directly as it may damage it.
7. With the sensor facing downward, slowly screw the cap upward and counter clockwise. Some electrolyte will overflow.
8. Rinse the outer body of the probe and inspect the membrane for trapped gas bubbles. The cathode area should be free of bubbles.
9. While the probe is not in use, put the protective plastic cap on.

Connecting the probe

MA845 is connected to the meter through a DIN connector. With the meter off:

- Connect the probe to the DIN socket on the top of the meter.
- Align the pins and key then push the plug into the socket. Tighten the threaded ring.
- Mount the supplied metallic plate onto the meter. Tighten the screw to lock in place.
- Mount the arm holder over the metallic pin from the plate.
- Place the probe into the holder.

- Continue with probe conditioning (polarizing) function.

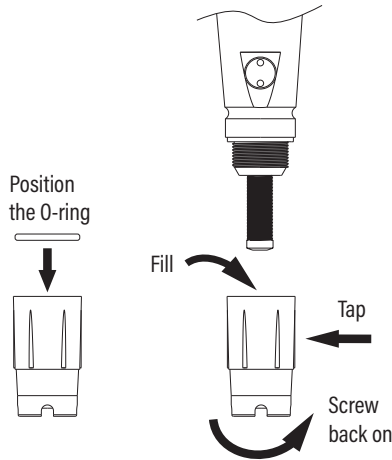

Probe Polarization

A new probe must be polarized before calibration.

- Connect the probe and power on the meter
- "DISSOLVED OXYGEN PROBE CONDITIONING" is displayed for about 60 seconds while the DO probe is conditioned. If the probe was previously conditioned and remained connected to the meter, press any key to enter measurement mode.

The DO probe is continuously polarized when connected to the meter. Polarization does not need to be performed unless maintenance is performed or the probe is disconnected from the meter.

The probe is polarized with a fixed voltage of approximately 800 mV between the cathode and anode. Probe polarization is essential for stable measurements. With the probe properly polarized, oxygen is continually consumed as it passes through the sensitive diaphragm and dissolves in the electrolyte solution contained in the probe.

If polarization is interrupted, the electrolyte solution continues to be enriched with oxygen until it reaches an equilibrium with the surrounding solution. Measurements taken with a non-polarized probe are drifty and inaccurate. The measurement will jump when the probe is moved.

Note: When not in use and during polarization, use the protective cap.

6.3. PROBE MAINTENANCE

The platinum cathode should always be bright and untarnished. If it is tarnished or stained, the cathode should be cleaned gently with a lint-free cloth.

- Rinse the probe with deionized or distilled water.
- Replace the membrane cap using fresh electrolyte. See PROBE PREPARATION procedure.
- Recalibrate the meter.

Membrane Maintenance

For accurate and stable measurements, perfect condition of the membrane surface is needed. Protect the thin membrane from scratches, abrasion or contact with solids.

If no measurements are taken for a few hours, protect the membrane with the plastic protective cap.

If fouled, rinse it carefully with distilled or deionized water. If damaged, replace the membrane cap.

Note: *Change the membrane every 8 weeks or more frequently if used in a specially fouling environment. Check and replace the electrolyte fill solution every 4 weeks.*

Storage

After taking the measurements, switch the meter off and clean the probe before storage. When not in use the probe should be stored with the plastic protective cap on.

For short term storage, the probe can also be stored in a beaker of deionized water with the protective plastic cap removed.

For long term storage, the probe should be stored dry:

1. Disconnect the probe from the meter
2. Unscrew the membrane cap
3. Remove any electrolyte solution from the cap
4. Rinse the probe anode/cathode assembly with distilled water and blot dry
5. Screw the membrane cap onto the probe until the membrane cap is hand tight

7. SETUP

To configure the meter settings, modify default values or set measurement parameters:

- Press SETUP to enter (or exit) Setup mode
- Use ▲▼ keys to navigate the menus (view parameters)
- Press CAL/EDIT to enter Edit mode (modify parameters)
- Press RANGE/▶ key to select between options
Use ▲▼ keys to modify values (value being modified is displayed blinking)
- Press GLP/ACCEPT to confirm and save changes (ACCEPT tag is displayed blinking)
- Press ESC (or CAL/EDIT again) to exit Edit mode without saving (return to menu)

7.1. SETUP OPTIONS

Log Type

Options: INTERVAL (default), MANUAL or STABILITY

Press RANGE/▶ to select between options.

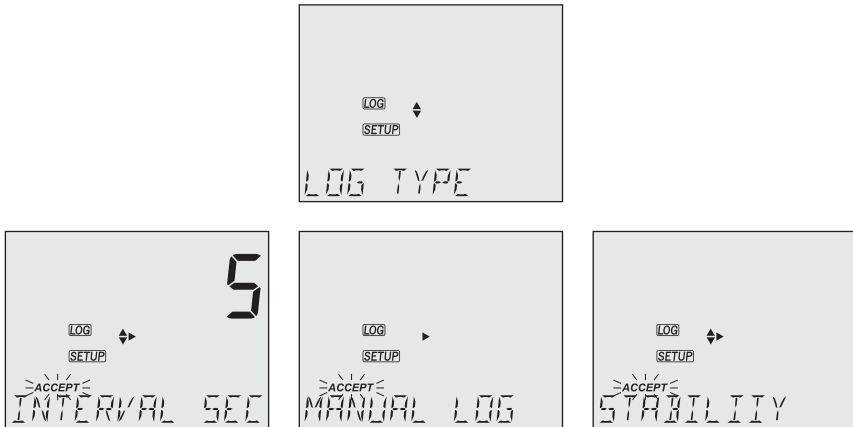

Use ▲▼ keys to set time interval: 5 (default), 10, 30 sec. or 1, 2, 5, 15, 30, 60, 120, 180 min.

Use ▲▼ keys to select stability type: fast (default), medium or accurate.

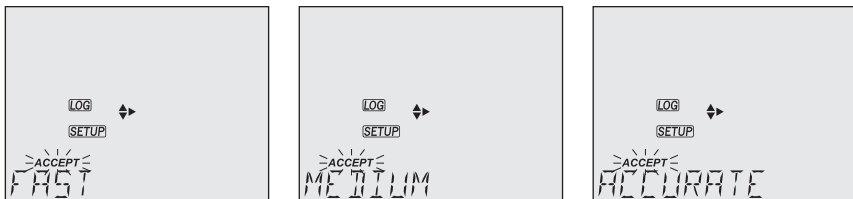

Calibration Expired Warning

Options: 1 to 7 days (default) or off

Use ▲▼ keys to select the number of days since last calibration has elapsed.

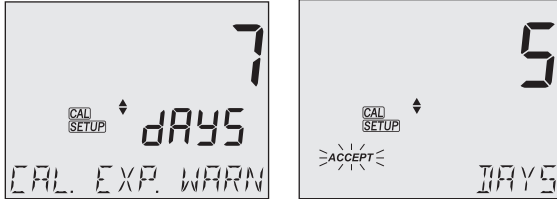

Altitude Compensation

Options: -500 to 4000 m

Use ▲▼ keys to set the appropriate altitude of the location.

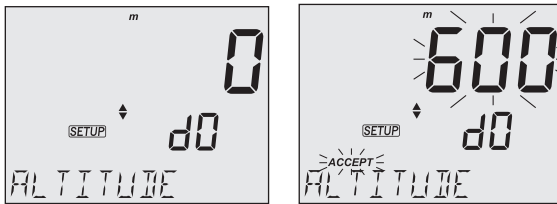

Salinity Compensation

Options: 0 to 40 g/L

Use ▲▼ keys to modify the value.

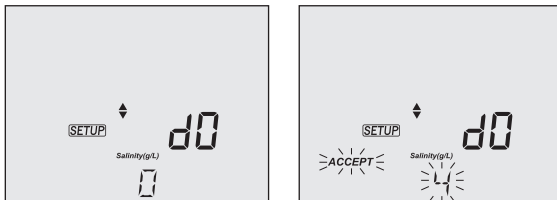

Dissolved Oxygen Unit

Options: ppm or mg/L

Press RANGE/▶ to navigate right and select the unit.

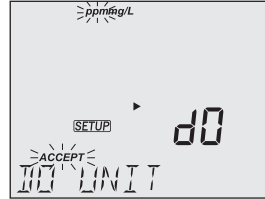
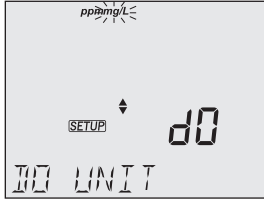

Date

Options: year, month or day

Press RANGE/▶ to select options. Use ▲▼ keys to modify the values.

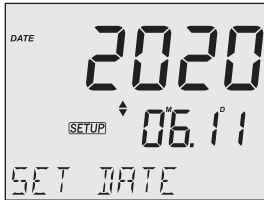

Time

Options: hour, minute or second

Press RANGE/▶ to select. Use ▲▼ keys to modify the values.

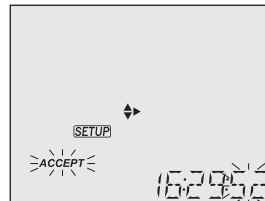

Auto Off

Options: 5, 10 (default), 30, 60 minutes or off

Use ▲▼ keys to select the time.

The meter will power off after set period of time.

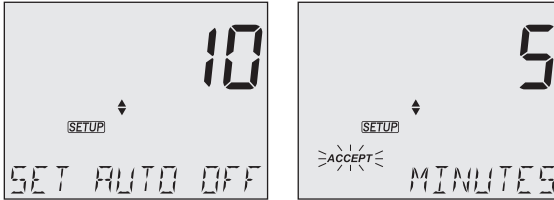

Sound

Options: enable (default) or disable

Use ▲▼ keys to select.

When pressed, each key will emit a short acoustic signal.

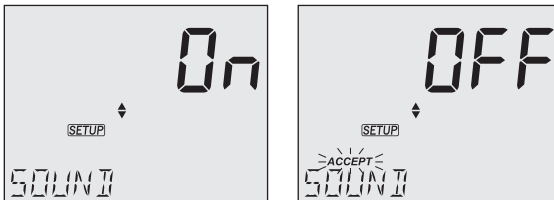

Temperature Unit

Options: °C (default) or °F

Use ▲▼ keys to select the unit.

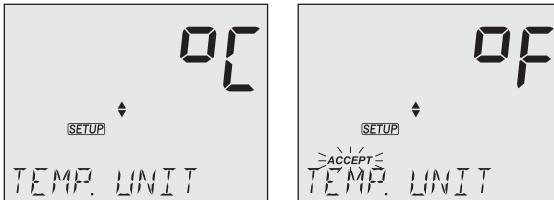

LCD Contrast

Options: 1 to 9 (default)

Use ▲▼ keys to select LCD contrast values.

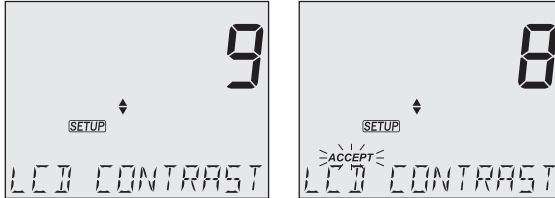

Default Values

Resets meter settings to factory defaults.

Press GLP/ACCEPT to restore the default values. "RESET DONE" message confirms that the meter performs with default settings.

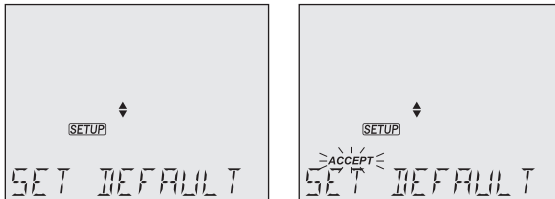

Instrument Firmware Version

Displays the installed firmware version.

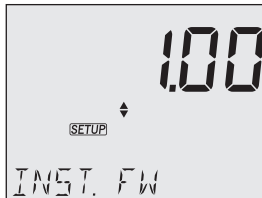

Meter ID / Serial Number

Use ▲▼ keys to assign a meter ID from 0000 to 9999.

Press RANGE/▶ to view the serial number.

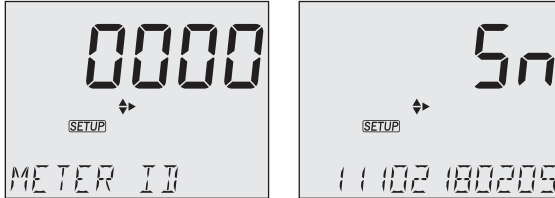

Separator Type

Options: comma (default) or semicolon

Use ▲▼ keys to select the columns separator for the CSV file.

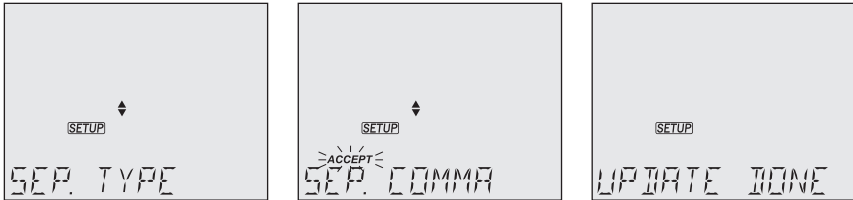

Export to PC / Log on Meter

Options: Export to PC and Log on Meter

With the micro USB cable connected, press SETUP. Press CAL/EDIT to enter Edit mode.

Use ▲▼ keys to select.

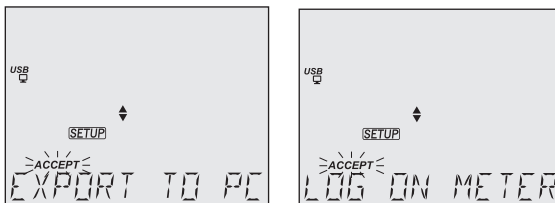

Note: This option is only available while connected to a PC. The USB/PC icon is not displayed if LOG ON METER option was previously set.

8. ALTITUDE & SALINITY COMPENSATION

Temperature, pressure (altitude) and salinity influence DO concentration.

Cold water holds more oxygen and therefore DO concentration increases with decreasing temperature. Compensation for temperature-related solubility is done automatically using the probe's built in temperature sensor.

Altitude compensation

When measurements are done at an altitude below sea level, oxygen solubility increases. Conversely for measurements made above sea level, the oxygen solubility decreases.

Select the approximate altitude in the SETUP menu (see Altitude Compensation for details).

Salinity compensation

The solubility of oxygen in water is also influenced by the amount of salt in the water.

Freshwater holds more oxygen than saltwater does.

Seawater typically has a salinity of 35 g/L and the oxygen solubility is 18 % less compared to fresh water at 25 °C. By entering the approximate salinity value, the calibration and subsequent concentration measurement will be compensated to display the correct oxygen concentration. A 18 % error would result if the salinity value is not entered.

The solubility of oxygen dissolved in water decreases in brackish or seawater; or for measurements made at above sea level altitude.

9. CALIBRATION

Ensure the probe is ready for measurements. Follow the procedure in PROBE PREPARATION section.

- Set the appropriate altitude and salinity compensation value (see SETUP OPTIONS section).
- For highest accuracy, complete all calibrations at a temperature as close as possible to the sample temperature.
- For an accurate calibration, it is recommended to wait for at least 15 minutes to ensure precise conditioning of the probe.
- Keep the protective cap on during polarization time and remove it for calibration and measurements.

The **MW190** accepts two % saturation calibration points; 100% using saturated air and 0% using zero oxygen solution. For most applications, air calibration is sufficient.

The meter should be recalibrated:

- Whenever the probe is replaced
- When high accuracy is required
- If "CAL EXPIRED" or "NO CAL" is displayed
- At least once a week

100% Saturated Calibration

The 100% calibration is performed in water-saturated air.

1. Pour water into a small beaker. Rinse the polarized probe with clean water.
2. Dry the probe tip and allow a few seconds for the LCD reading to stabilize (probe in air).
3. Hold the probe in air over the beaker. Avoid any contact of the membrane with water.
4. Press CAL/EDIT to enter calibration.
LCD displays 100.0% with "WAIT" (blinking) and hourglass symbol until the reading is stable. When the reading is stable and within the limits, LCD displays "STD" with ACCEPT tag (blinking).
5. Press GLP/ACCEPT key to confirm.
LCD displays "0.0%" calibration point and "WAIT" (blinking).
6. Press CAL/EDIT. LCD displays "SAVING", stores the calibration value and returns to Measurement mode.

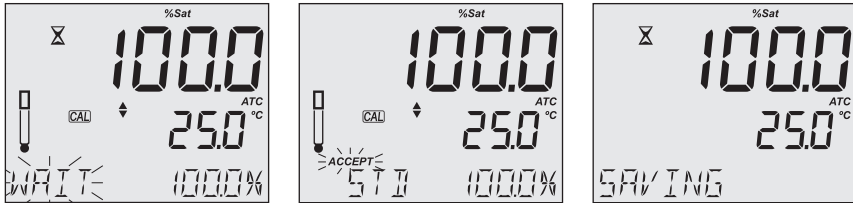

Note: If DO is a critical parameter or sample has low DO value, it is recommended to perform a second calibration point or a check using a zero calibration DO solution.

Zero Calibration

Continue after confirming the 100% calibration point.

If no previous 100% calibration has been performed, press CAL/EDIT. Use ▲▼ keys to select the 0% point.

1. Pour **MA9070** Zero oxygen solution into a small beaker.
2. Submerge the membrane cap and temperature sensor into the beaker and stir gently for 2-3 minutes. When the reading is stable and within the limits, LCD displays "STD" with ACCEPT tag (blinking).
3. Press GLP/ACCEPT key to confirm.

If this is the second calibration point, LCD displays "SAVING", stores the calibration and returns to Measurement mode.

If no previous 100% calibration exists, LCD displays "100.0%" calibration point and "WAIT" (blinking). Continue with the second point or pres CAL/EDIT to save.

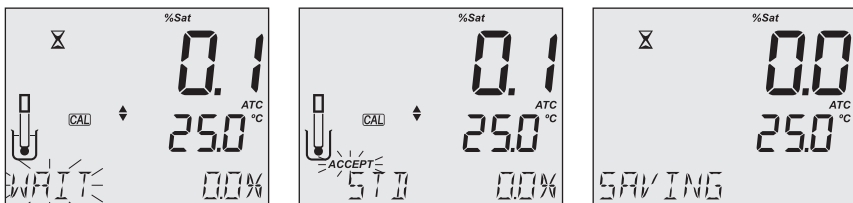

Note: Rinse probe tip in water before measurements in samples.

Clear Calibration

1. Press CAL/EDIT to enter Calibration mode.
LCD displays "CLEAR CALIBRATION" with ACCEPT tag (blinking).
2. Press LOG/CLEAR.
LCD displays "PLEASE WAIT" followed by "NO CAL".

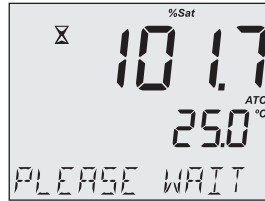
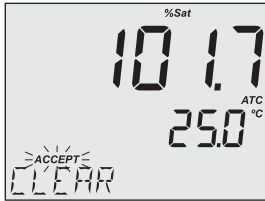

Calibration Messages & Warnings

- "WRONG STANDARD" is displayed if the reading exceeds the expected value. Calibration can not be confirmed. Check that correct calibration solution has been used and / or clean the probe. See PROBE PREPARATION section for details.

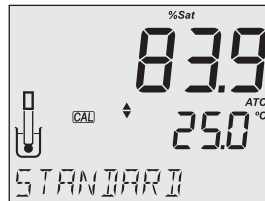
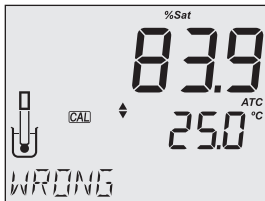

- "WRONG STANDARD TEMPERATURE" is displayed if the temperature of the solution is out of temperature compensation interval. Use fresh calibration solution and / or clean the temperature sensor.

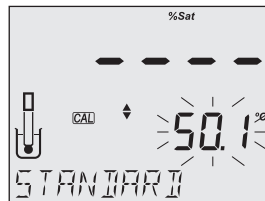
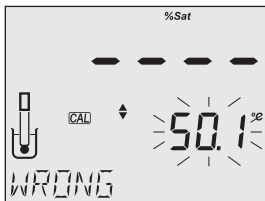

10. MEASUREMENT

When connected, **MA845** probe is automatically recognized.

- Make sure that the probe is polarized, calibrated and the protective cap has been removed.
- Rinse the probe.
- Submerge the probe in the sample to be tested, make sure the temperature sensor is also immersed.
- Allow time for the reading to stabilize.

Note: *The sample should be stirred when taking a reading.*

The measured DO value (in %) is displayed on the first LCD line, the temperature on the second LCD line and additional information on the third LCD line.

Use the ▲▼ keys to select information displayed on the third LCD line (altitude, salinity, time, date and battery status).



Press RANGE/▶ to toggle the DO reading, %Sat or mg/L (ppm).

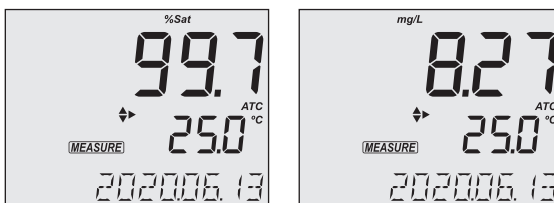

Measurement Messages & Warnings

- "OUT OF SPEC" is displayed if the measurement exceeds the specified DO probe limits. The DO range upper limit is displayed blinking.

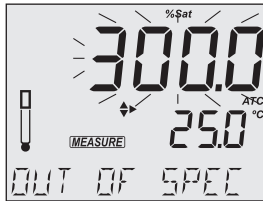

- "OUT OF SPEC" is displayed if the temperature is outside temperature compensation interval. Temperature reading is performed. DO reading is not performed.
- "TEMP OUT OF SPEC" is displayed if the temperature is outside temperature probe limit. Temperature limit is displayed blinking. Neither temperature nor DO reading is performed.

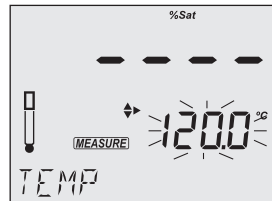
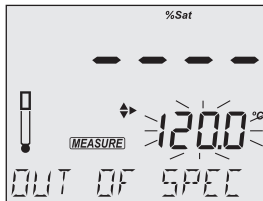
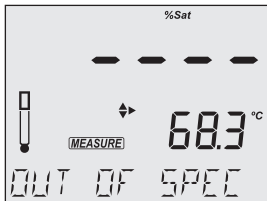

- "NO CAL" message indicates that the instrument needs to be calibrated or that the previous calibration has been deleted.
- "CAL EXPIRED" message indicates the set number of days since last calibration has elapsed and the instrument needs to be calibrated.
- "NO PROBE" message is displayed when the probe is not connected.

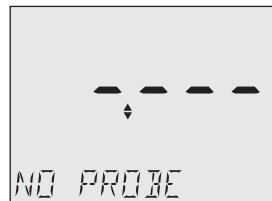
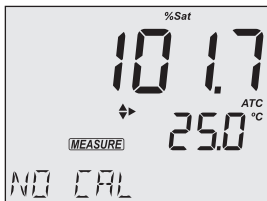

11. LOGGING

MW190 supports three types of logging: manual log on demand, log on stability and interval logging. See Log Type in SETUP OPTIONS section.

The meter can hold up to 1000 log records. Up to 200 for manual log on demand, up to 200 for log on stability and up to 1000 for interval logging. See DATA MANAGEMENT section.

Note: *An interval logging lot can hold up to 600 records. When an interval logging session exceeds 600 records, another lot file is automatically generated.*

11.1. TYPES OF LOGGING

Manual log on demand

- Readings are logged each time LOG/CLEAR is pressed
- All manual readings are stored in a single lot (i.e. records made on different days share the same lot)

Log on stability

- Readings are logged each time LOG/CLEAR is pressed and stability criteria is reached
- Stability criteria can be set to fast, medium or accurate
- All stability readings are stored in a single lot (i.e. records made on different days are logged in the same lot)

Interval logging

- Readings are logged continuously at a set time interval (e.g. every 5 or 10 minutes).
- Records are added to it until the session stops.
- For each interval logging session, a new lot is created.

Note: *At the end of the logging session the meter returns to measurement screen.*

A complete set of GLP information is stored with each log. See GLP section for details.

Manual Log on Demand

1. From the Setup mode, set Log Type to MANUAL.
2. From the measurement screen press LOG/CLEAR.
LCD displays "PLEASE WAIT". The LOG ### "SAVED" screen displays stored log number.
"FREE" ### screen displays the number of available records.

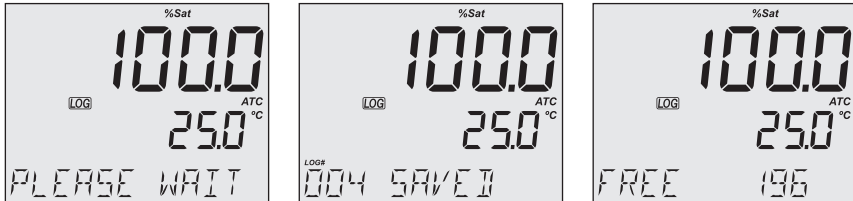

Log on Stability

1. From the Setup mode, set Log Type to STABILITY and the desired stability criteria.
2. From the measurement screen press LOG/CLEAR.
LCD displays "PLEASE WAIT" then "WAITING", until stability criteria is reached.

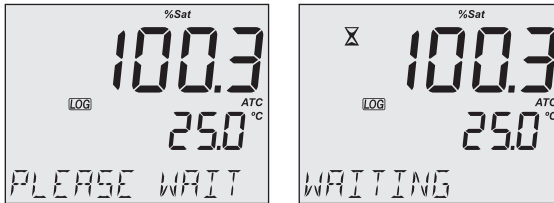

Note: Pressing ESC or LOG/CLEAR with "WAITING" displayed, exits without logging.
The LOG ### "SAVED" screen displays stored log number. "FREE" ### screen displays total number of available records.

Interval Logging

1. From the Setup mode, set Log Type to INTERVAL (default) and desired time interval.
2. From the measurement screen press LOG/CLEAR.
LCD displays "PLEASE WAIT". The LOG ### LOT ### screen displays the measurement log number (bottom left) and interval logging session lot number (bottom right).
3. Press RANGE/▶ during logging to display the number of available records ("FREE" ###). Press RANGE/▶ again to return to return to active logging screen.
4. Press LOG/CLEAR again (or ESC) to end current interval logging session. LCD displays "LOG STOPPED".

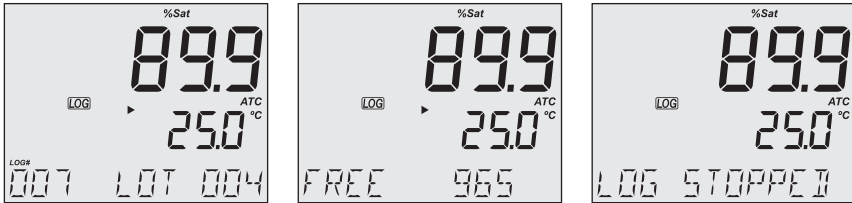

Interval Logging Warnings

"OUT OF SPEC"	Measurement is out of spec. Log continues.
"MAX LOTS"	Maximum number of lots reached (100). Cannot create new lots.
"LOG FULL"	Log space is full (1000 logs limit was reached). Logging stops.

11.2. DATA MANAGEMENT

- A lot contains 1 to 600 log records (saved measurement data)
- Maximum number of lots that can be stored is 100, excluding Manual and Stability
- Maximum number of log records that can be stored is 1000, across all lots
- Manual and Stability logs can store up to 200 records (each)
- Interval logging sessions (across all 100 lots) can store up to 1000 records. When a logging session exceeds 600 records a new lot will be created.
- Lot names are automatically allocated by the meter from 001 up to 999 incrementally, even after some lots have been deleted. If max number of lots is reached (e.g. lot name DOLOT100) and 50 lots are deleted, another 50 lots from DOLOT101 to DOLOT150, can be stored.
- Once lot name 999 is assigned, to reset lot naming to 001, all lots have to be deleted. See Deleting Data section.

11.2.1. Viewing Data

1. Press RCL to access the logged data.

LCD displays "PLEASE WAIT" followed by "LOG RECALL" with ACCEPT tag blinking and the number of stored logs.

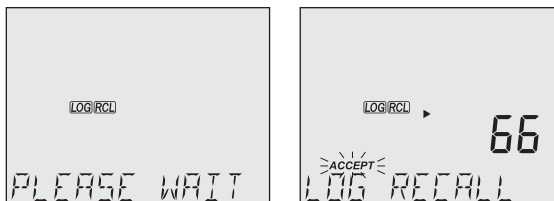

Note: Press RANGE/▶ to export all saved lots to external storage.

2. Press GLP/ACCEPT to confirm.
3. Use ▲▼ keys to select the lot type (MANUAL, STABILITY or interval ###).

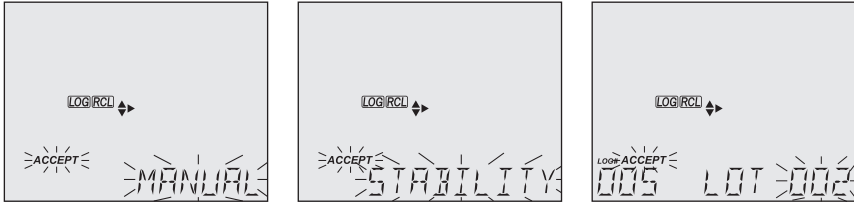

Note: Press RANGE/▶ to export only the selected lot to external storage.

4. Press GLP/ACCEPT to confirm.
5. With a lot selected, use ▲▼ keys to view the records stored in that lot.
6. Press RANGE/▶ to view, additional log data on the third LCD line: altitude, salinity, date, time, calibration points, lot info.

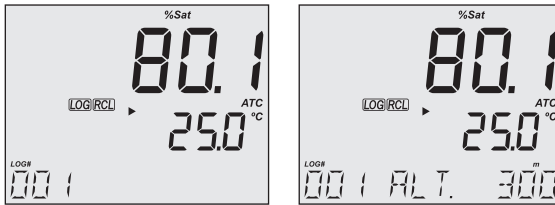

11.2.2. Deleting Data

Manual Log on Demand & Stability Log

1. Press RCL to access the logged data.
LCD displays "PLEASE WAIT" followed by "LOG RECALL" with ACCEPT tag blinking and the number of stored logs.
2. Press GLP/ACCEPT to confirm.
3. Use ▲▼ keys to select MANUAL or STABILITY lot type.

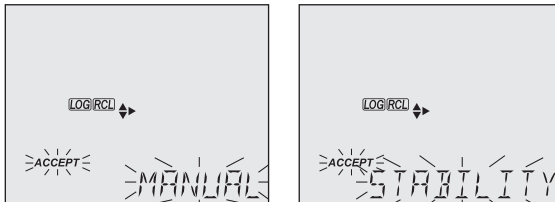

4. With a lot selected, press LOG/CLEAR to delete entire lot.
"CLEAR" is displayed with ACCEPT tag and lot name blinking.
5. Press GLP/ACCEPT to confirm (to exit, press ESC or CAL/EDIT or LOG/CLEAR). "PLEASE WAIT" with ACCEPT tag blinking is displayed, until the lot is deleted.
After the selected lot has been deleted, "CLEAR DONE" displays briefly.
Display shows "NO MANUAL / LOGS" or "NO STABILITY / LOGS":



Individual Logs / Records

1. Press RCL to access the logged data.
LCD displays "PLEASE WAIT" followed by "LOG RECALL" with ACCEPT tag blinking and the total number of logs.
2. Press GLP/ACCEPT to confirm.
3. Use ▲▼ keys to select MANUAL or STABILITY lot type.
4. Press GLP/ACCEPT to confirm.
5. Use the ▲▼ to navigate between logs. Log record number displays on the left.
6. With desired log record selected, press LOG/CLEAR to delete.
"DELETE" is displayed with ACCEPT tag and log ### blinking.
7. Press GLP/ACCEPT to confirm (to exit, press ESC or CAL/EDIT or LOG/CLEAR).
"DELETE" and Log ### blinking is displayed, until the log is deleted.
After the log has been deleted "CLEAR DONE" message displays briefly.
Display shows logged data of the next log ###.



Note: Logs stored within an interval lot can not be deleted individually.

Log on Interval

1. Press RCL to access the logged data.
LCD displays "PLEASE WAIT" followed by "LOG RECALL" with ACCEPT tag blinking and the total number of logs.
2. Press GLP/ACCEPT to confirm.
3. Use ▲▼ keys to select an interval logging lot number.
The LOG ### LOT ### screen displays selected lot number (bottom right) and total logs stored in lot (bottom left).
4. Press GLP/ACCEPT to confirm (to exit, press ESC or CAL/EDIT; or LOG/CLEAR).
5. With the lot selected, press LOG/CLEAR to delete entire lot.
"CLEAR" is displayed with ACCEPT tag and lot name blinking.

Note: Use ▲▼ keys to select a different lot number.

6. Press GLP/ACCEPT to confirm (to exit, press ESC or CAL/EDIT or LOG/CLEAR).
"PLEASE WAIT" with ACCEPT tag blinking is displayed, until the lot is deleted.
After deletion "CLEAR DONE" message displays briefly.
Display shows the previous lot ###.

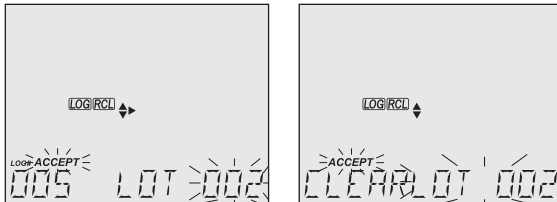

Delete All

1. Press RCL to access the logged data.
LCD displays "PLEASE WAIT" followed by "LOG RECALL" with ACCEPT tag blinking and the number of stored logs.
2. Press LOG/CLEAR to delete all logs.
"CLEAR ALL" is displayed with ACCEPT tag blinking.
3. Press GLP/ACCEPT to confirm (to exit, press ESC or CAL/EDIT; or LOG/CLEAR).
"PLEASE WAIT" is displayed with a percentage counter, until all logs are deleted.
After deletion "CLEAR DONE" message displays briefly.
Display returns to the log recall screen.

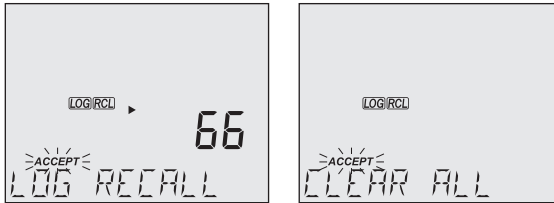

11.2.3. Exporting Data

PC Export

1. With the meter on, use the supplied micro USB cable to connect to a PC.
2. Press SETUP then CAL/EDIT.
3. Use the ▲▼ keys and select "EXPORT TO PC".
The meter is detected as a removable drive. LCD displays the PC icon.
4. Use a file manager to view or copy files on the meter.

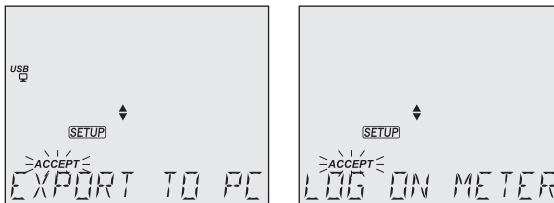

When connected to a PC, to enable logging:

- Press LOG/CLEAR. LCD displays "LOG ON METER" with ACCEPT tag blinking.
- Press GLP/ACCEPT. Meter disconnects from the PC and the PC icon is no longer displayed.
- To return to "EXPORT TO PC" mode, follow steps 2 and 3 above.

Exported data file details:

- The CSV file (comma separated values) may be opened with a text editor or spreadsheet application.
- The CSV file encoding is Western Europe (ISO-8859-1).
- Field separator may be set as comma or semicolon. See Separator Type in SETUP OPTIONS section.
- Interval log files are named ECLOT###, where ### is the lot number (e.g. ECLOT051).
- Manual log file is named ECLOTMAN and stability log file is named ECLOTSTA.

USB Export All

1. With the meter on, insert a USB flash drive into the micro USB port located on top of the meter. If the flash drive does not have a micro USB connector, use an adapter.
2. Press RCL then RANGE/▶ to select the "EXPORT ALL" option.
3. Press GLP/ACCEPT to confirm.
LCD displays "EXPORTING" and the percentage counter, followed by "DONE" when export is completed. Display returns to the lot selection screen.

Note: The USB flash drive can be safely removed if the USB icon is not displayed. Do not remove the USB drive during export.

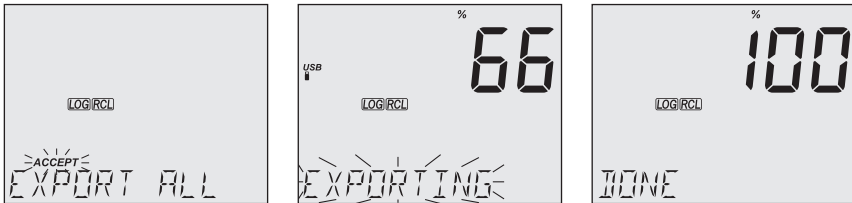

Overwriting existing data:

1. When the LCD displays "OVR" with LOT### blinking (USB icon is displayed), an identical named lot exists on the USB.
2. Press ▲▼ keys to select between YES, NO, YES ALL, NO ALL (ACCEPT tag blinking).
3. Press GLP/ACCEPT to confirm. Not confirming exits the export.
Display returns to lot selection screen.

USB Export Selected

Logged data can be transferred separately by lots.

1. Press RCL to access the logged data.
LCD displays "PLEASE WAIT" followed by "LOG RECALL" with ACCEPT tag blinking and the number of stored logs.
2. Press GLP/ACCEPT to confirm.
3. Use ▲▼ keys to select the lot type (MANUAL, STABILITY or interval ###)

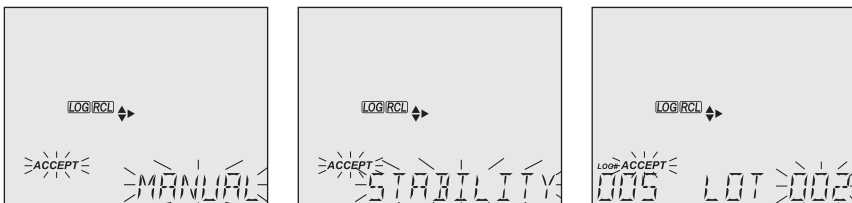

4. With the lot selected, press RANGE/▶ to export to USB flash drive.
 LCD displays "PLEASE WAIT" followed by "EXPORTING" with ACCEPT tag and selected lot name (MAN / STAB / ###) blinking.
 LCD displays "EXPORTING" and the percentage counter, followed by "DONE" when export is completed. Display returns to the lot selection screen.

Note: *The USB flash drive can be safely removed if the USB icon is not displayed. Do not remove the USB drive during export.*

Overwriting existing data.

1. When the LCD displays "EXPORT" with ACCEPT and lot number blinking (USB icon displayed), an identical named lot exists on the USB.
2. Press GLP/ACCEPT to continue. LCD displays "OVERWRITE" with ACCEPT tag blinking.
3. Press GLP/ACCEPT (again) to confirm. Not confirming exits the export.
 Display returns to lot selection screen.

Data Management Warnings

"NO MANUAL / LOGS"	No manual records saved. Nothing to display.
"NO STABILITY / LOGS"	No stability records saved. Nothing to display.
"OVR" with lot ### (blinking)	Identically named lots on USB. Select overwrite option.
"NO MEMSTICK"	USB drive is not detected. Data can not be transferred. Insert or check the USB flash drive.
"BATTERY LOW" (blinking)	When low battery, export is not executed. Recharge the battery.

Logged Data Warnings in CSV file

°C!	Probe used beyond its operation specifications. Data not reliable.
-----	--

12. GLP

Good Laboratory Practice (GLP) allows the user to store and recall calibration data. Correlating readings with specific calibrations ensures uniformity and consistency. Calibration data is stored automatically after a successful calibration. GLP information is included with every data log.

- Press GLP/ACCEPT.
- Use ▲▼ keys to scroll through the calibration data displayed on the third LCD line.
- Press ESC or GLP/ACCEPT to return Measurement mode.

12.1. DO INFORMATION

Calibration data displayed on the third LCD line:

- Calibration standards and temperature
- User selected altitude and salinity compensation values
- Time, date
- Calibration expiration time

“EXP WARN DIS” is displayed if calibration expiration time is disabled.

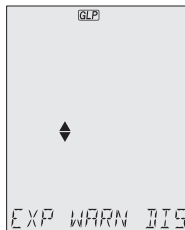

“NO CAL” is displayed blinking if no calibration has been performed (or calibration has been deleted).

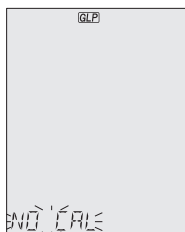

13. TROUBLESHOOTING

Symptoms	Problem	Solution
Reading fluctuates up and down (noise)	DO probe electrolyte contains air bubbles	Remove cap. Refill, tap and reinstall.
Blinking DO reading	Reading is out of range	Remove cap. Inspect and clean or replace if necessary. Stir or increase flow rate.
Meter fails to calibrate or gives faulty readings	Broken probe	Replace the probe.
LCD tags displayed continuously at startup	ON/OFF key is blocked	Check the keyboard. If error persists, contact Milwaukee Technical Service.
"Internal Er X"	Internal hardware error	Restart the meter. If error persists, contact Milwaukee Technical Service.

14. ACCESSORIES

MA845	DO and Temperature polarographic probe with DIN connector
MA841	Spare membrane and o-ring (5 pcs.)
MA9070	Zero oxygen solution, 230 ml
MA9071	Refilling electrolyte solution, 30 ml
MA9310	12 Vdc adapter, 220 V
MA9311	12 Vdc adapter, 110 V
MA9315	Electrode holder

CERTIFICATION

Milwaukee Instruments conform to the CE European Directives.



RoHS
compliant



Disposal of Electrical & Electronic Equipment. Do not treat this product as household waste. Hand it over to the appropriate collection point for the recycling of electrical and electronic equipment.

Please note: proper product and battery disposal prevents potential negative consequences for human health and the environment. For detailed information, contact your local household waste disposal service or go to www.milwaukeeinstruments.com (US only) or www.milwaukeeinst.com.

RECOMMENDATION

Before using this product, make sure it is entirely suitable for your specific application and for the environment in which it is used. Any modification introduced by the user to the supplied equipment may compromise the meter's performance. For your and the meter's safety do not use or store the meter in hazardous environment. To avoid damage or burn, do not perform any measurement in microwave ovens.

WARRANTY

This instrument is warranted against defects in materials and manufacturing for a period of 3 years from the date of purchase. Electrodes and Probes are warranted for 6 months. This warranty is limited to repair or free of charge replacement if the instrument cannot be repaired. Damage due to accidents, misuse, tampering or lack of prescribed maintenance is not covered by warranty. If service is required, contact your local Milwaukee Instruments Technical Service. If the repair is not covered by the warranty, you will be notified of the charges incurred. When shipping any meter, make sure it is properly packaged for complete protection.

Milwaukee Instruments reserves the right to make improvements in design, construction and appearance of its products without advance notice.

THANK YOU FOR CHOOSING



Authorized Distributor in Australia
Pacific Sensor Technologies Pty Ltd

Unit 4, 3 Neutron Place Rowville, VIC 3178 Australia

1300 662 720 | sales@pacificsensortech.com.au

www.pacificsensortech.com.au